

Armadio

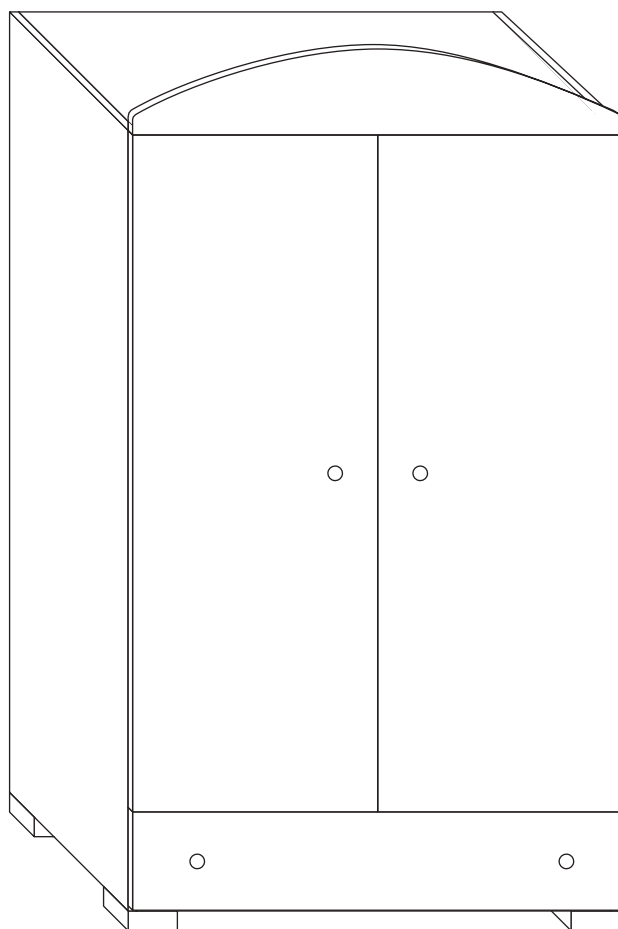

**IMPORTANTE: LEGGERE ATTENTAMENTE
E CONSERVARE PER UN UTILIZZO FUTURO**

***IMPORTANT: READ CAREFULLY
AND RETAIN THIS SHEET FOR FURTHER USE***

Istruzioni di montaggio

ISTRUZIONI E PRECAUZIONI D'USO

- Non appendersi alle ante o appendere ad esse masse, ne' esercitare contro di esse una pressione impropria quando sono aperte.
- Non salire con i piedi sull'armadio ne' sui suoi ripiani interni, ne' sulle ante.
- Non caricare ripiani con più di 25 kg ciascuno ed i cassetti con più di 4 kg ciascuno.
- Evitare di intervenire per manutenzioni sui componenti dell'armadio se l'operazione non viene eseguita da una persona esperta; per ogni evenienza contattare il rivenditore o direttamente il produttore all'indirizzo indicato in copertina.
- Evitare che le superfici, soprattutto quelle orizzontali, rimangano a contatto con l'acqua o con altri liquidi, anche per brevi periodi.
- Non avvicinarsi con fiamme libere. riferibilmente non esporre alla luce diretta del sole.
- Non esporre a fonti di calore dirette (stufette elettriche, a gas, ecc.).
- Il montaggio deve essere eseguito seguendo scrupolosamente le istruzioni allegate.
- Non appendere l'armadio in modo pensile. verificare periodicamente il serraggio di tutte le ferramente di montaggio (eccentrici, cerniere ante, ecc.).
- Una volta dimesso, l'armadio con i suoi componenti non vanno dispersi nell'ambiente ma conferiti ai sistemi pubblici di smaltimento.

CARE OVER USE INSTRUCTIONS

- *Do not hang yourself on wardrobe's doors, do not hang anything heavy and do not press improperly on wardrobe's doors especially when they are open.*
- *Do not stand on the wardrobe and neither on its shelves, drawer or doors.*
- *Do not fill wardrobe's shelf with more than 25 kg each and do not fill wardrobe's drawer with more than 4 kg.*
- *Do not try to fix any of wardrobe's elements up if you are not professionally skilled to do it, for any reason please contact your shop or the producer directly.*
- *Do not let especially horizontal surfaces to be wet with water or other liquids even for a short period.*
- *Do not approach the wardrobe with fire flames. If possible do not expose the wardrobe to direct sun light.*
- *Do not expose the wardrobe to heat sources (gas or electric heaters).*
- *Do not hang the wardrobe on the wall.*
- *Do a periodically control on the tightening of all wardrobe's hardware.*
- *At the end of its use do not scatter the various components of the wardrobe in the environment, but bring it to a public waste disposal.*



Lista dei componenti - Parts list

Componenti armadio Wardrobe parts

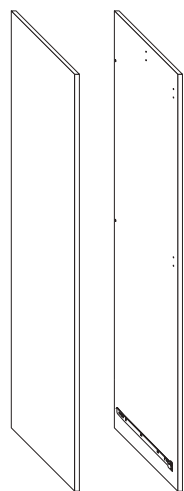

1xA1 + 1xA2
Fianchi sinistro+destra
Left+right side panels

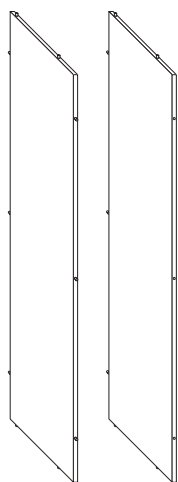

1xB1 + 1xB2
Schiene sinistra+destra
Left+right back panels

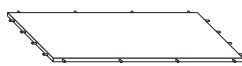

1xC
Coperchio
Top panel

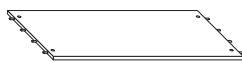

1xD
Piano centrale
Medium panel

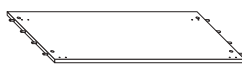

1xE
Fondo
Bottom panel



1xF
Fipiano
Front rail



1xH
Ante
Doors



1xQ
Piedini
Feet



1xR
Tubi appendiabiti
Clothes hanging rail



1xO
Fascia frontale
Front rail



1xJ
Cimasa
Top frontal panel

Componenti cassetto Drawer parts



1xL
Pannello frontale
Front panel



1xM
Pannello posteriore
Back panel



1xN1
Lato sinistro
Left panel

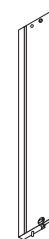

1xN2
Lato destro
Right panel

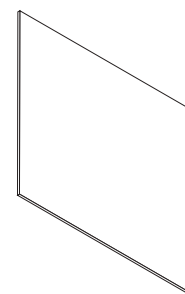

1xP
Fondo
Bottom panel

Ferramenta Hardware parts

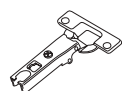

6xa



6xb



24xc
15mm



12xd

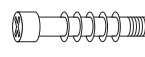

12xe
36mm

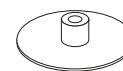

12xf



4xg



2xh



4xi
20mm



4xj

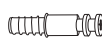

4xk



4xm



1xn



12xf



4xq

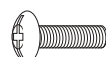

4xr
20mm



8xt
50mm



4xv
25mm



2xw
30mm

Attrezzi necessari Tools needed



Step
1

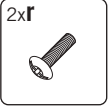
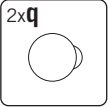
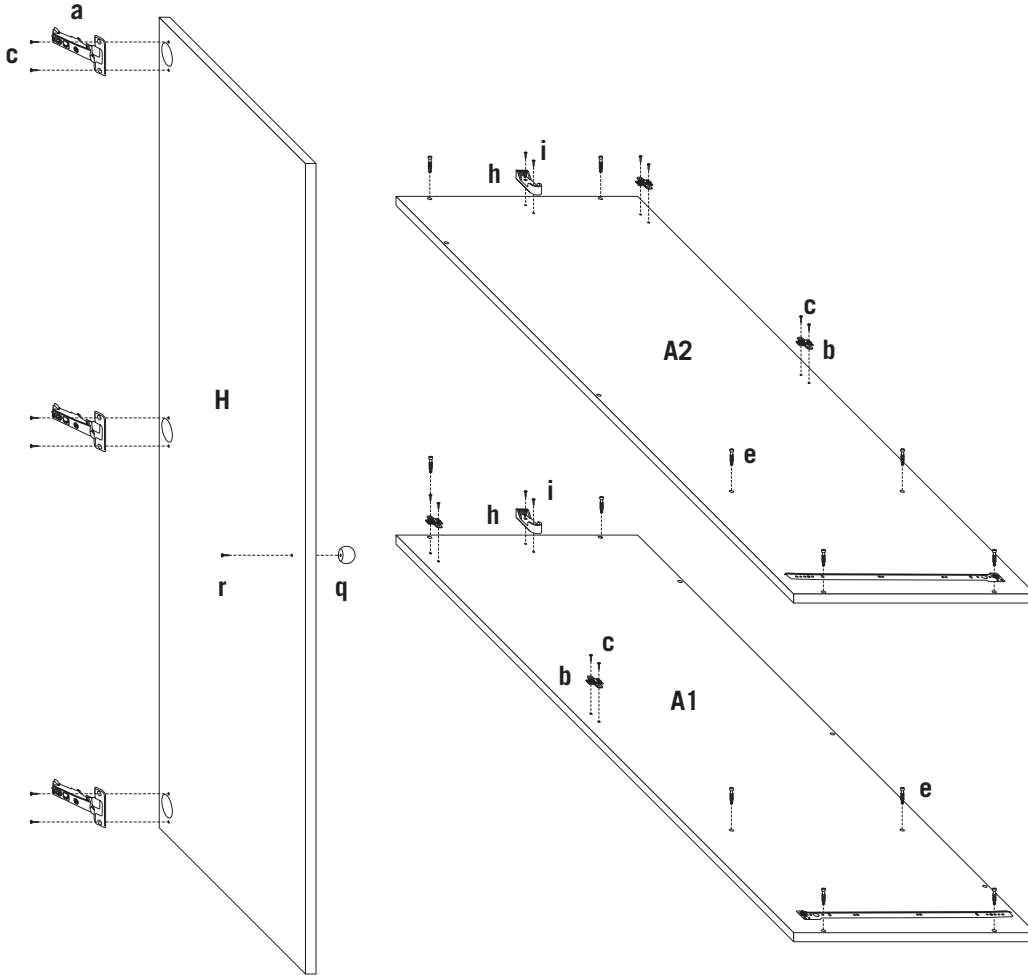

Step
2

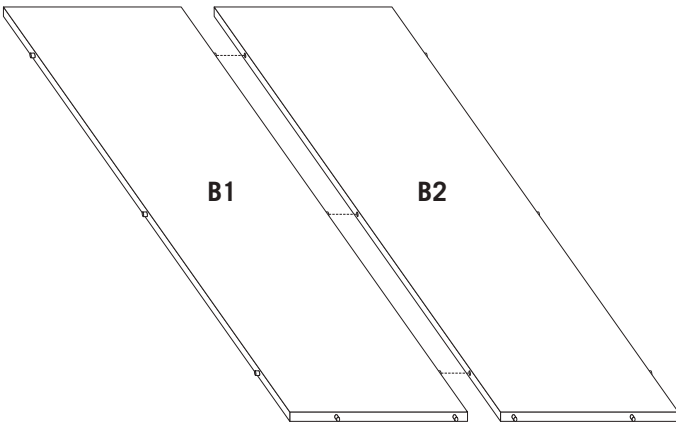

Step
3

Coperchio **C**
Top **C**

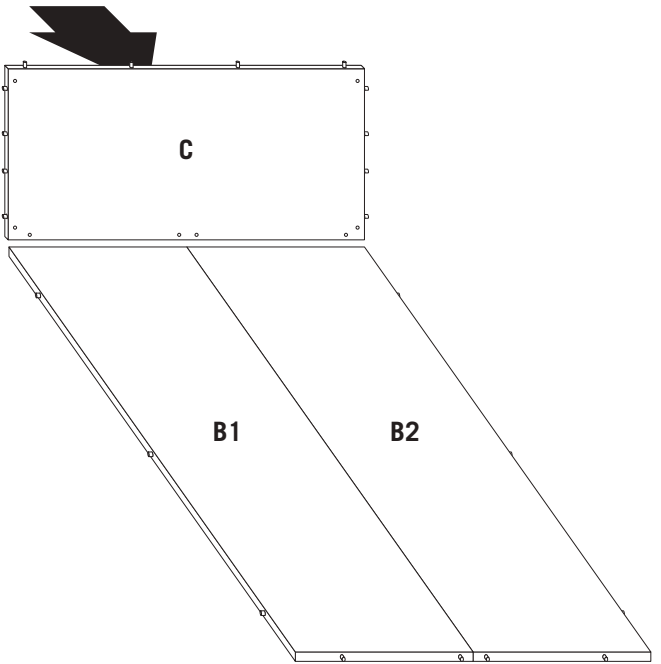

Step
4

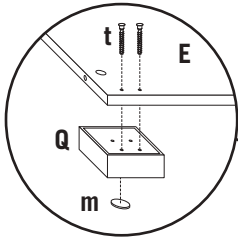

Montare i quattro piedi **Q** sotto il fondo **E** prima di assemblare la scocca.
*Apply the four feet **Q** below the bottom panel **E** before the assembly of the frame.*

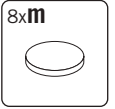
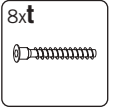
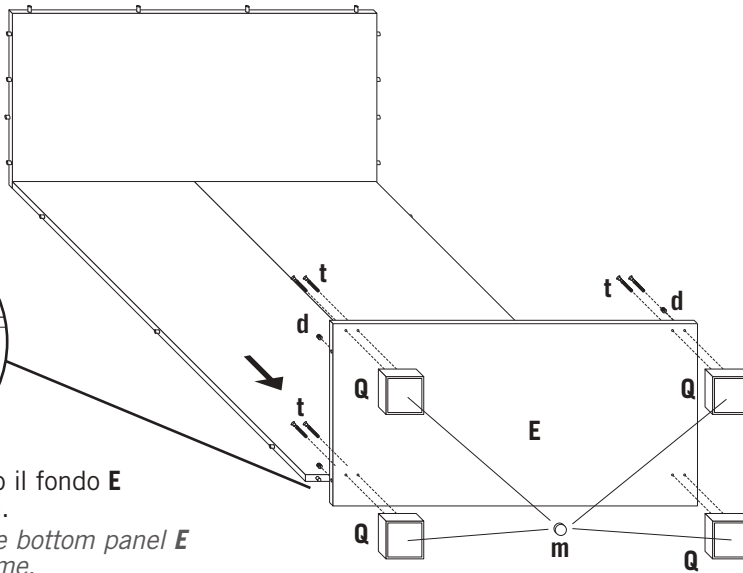

Step
5

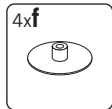
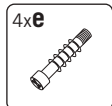
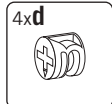
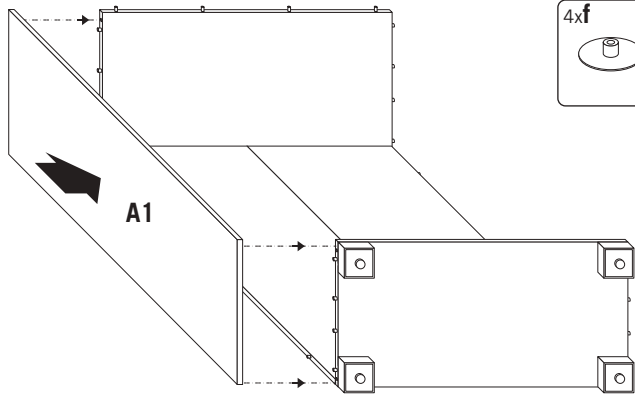
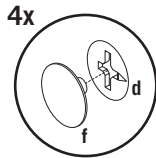

Step
6

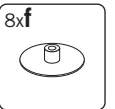
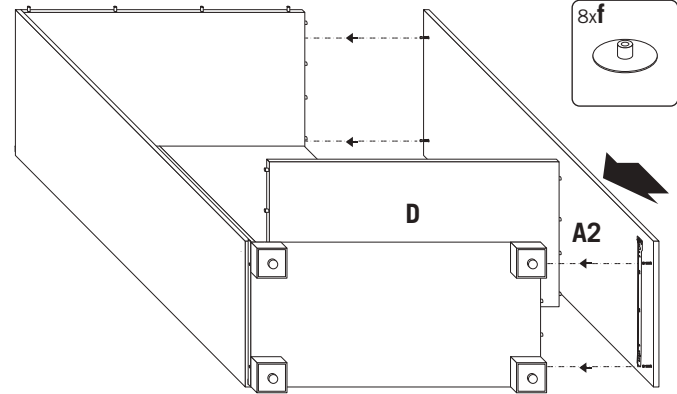

Step
7

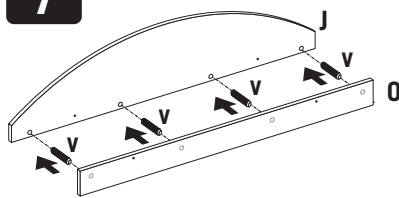

1° montare le spine **v**

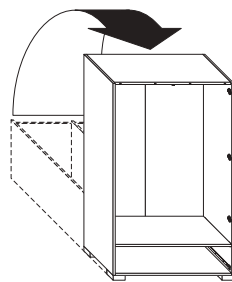

3° ribaltare l'armadio

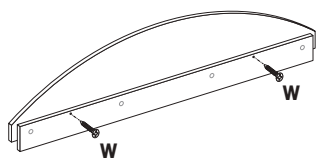

2° avvitare le viti **w**

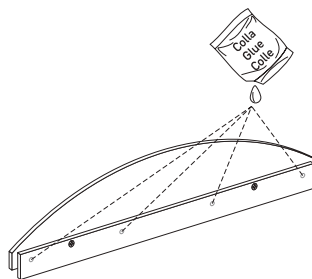

4° mettere colla nei fori

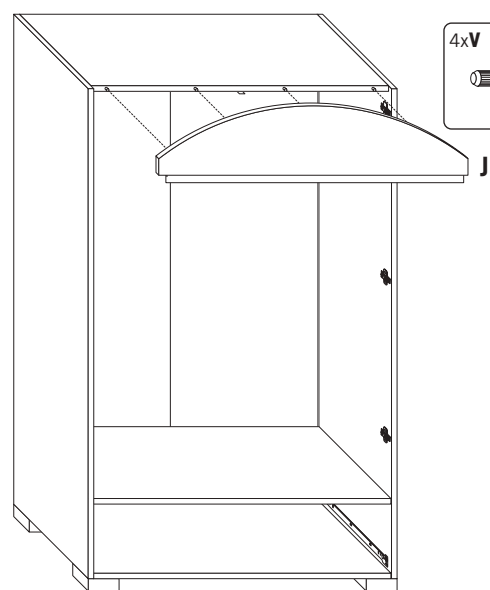

5° montare la cimassa previamente assemblata

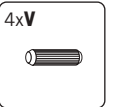

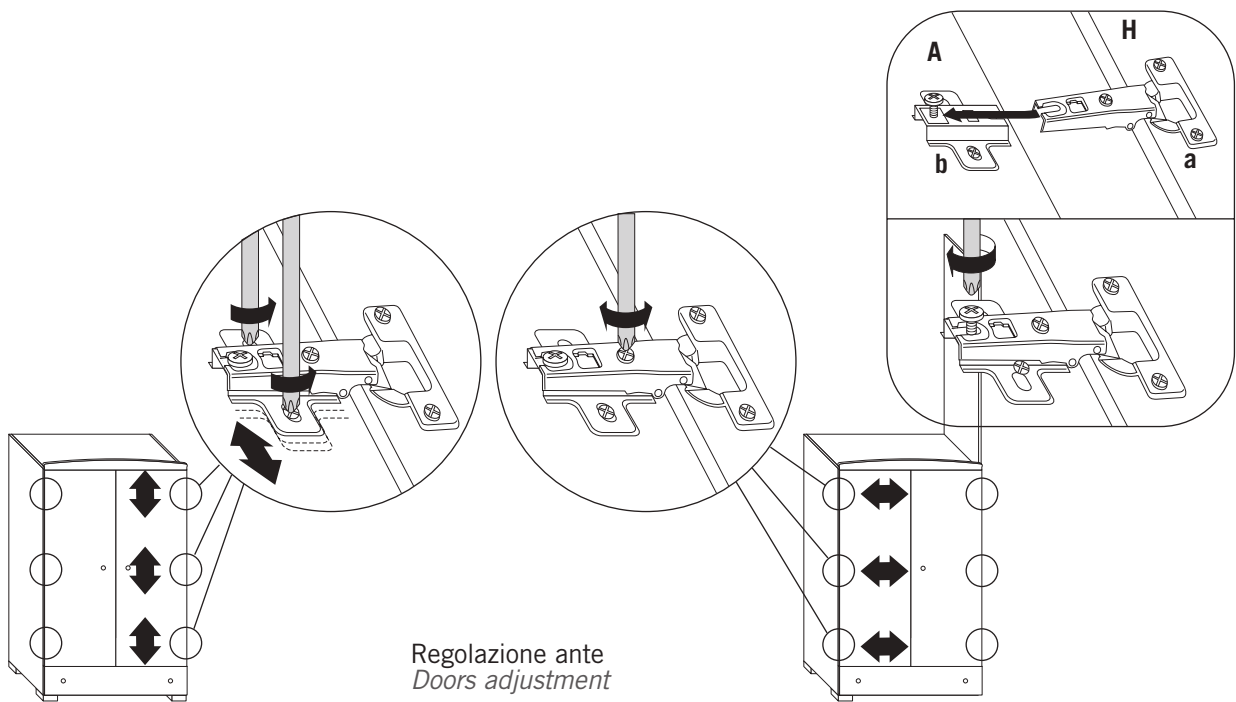
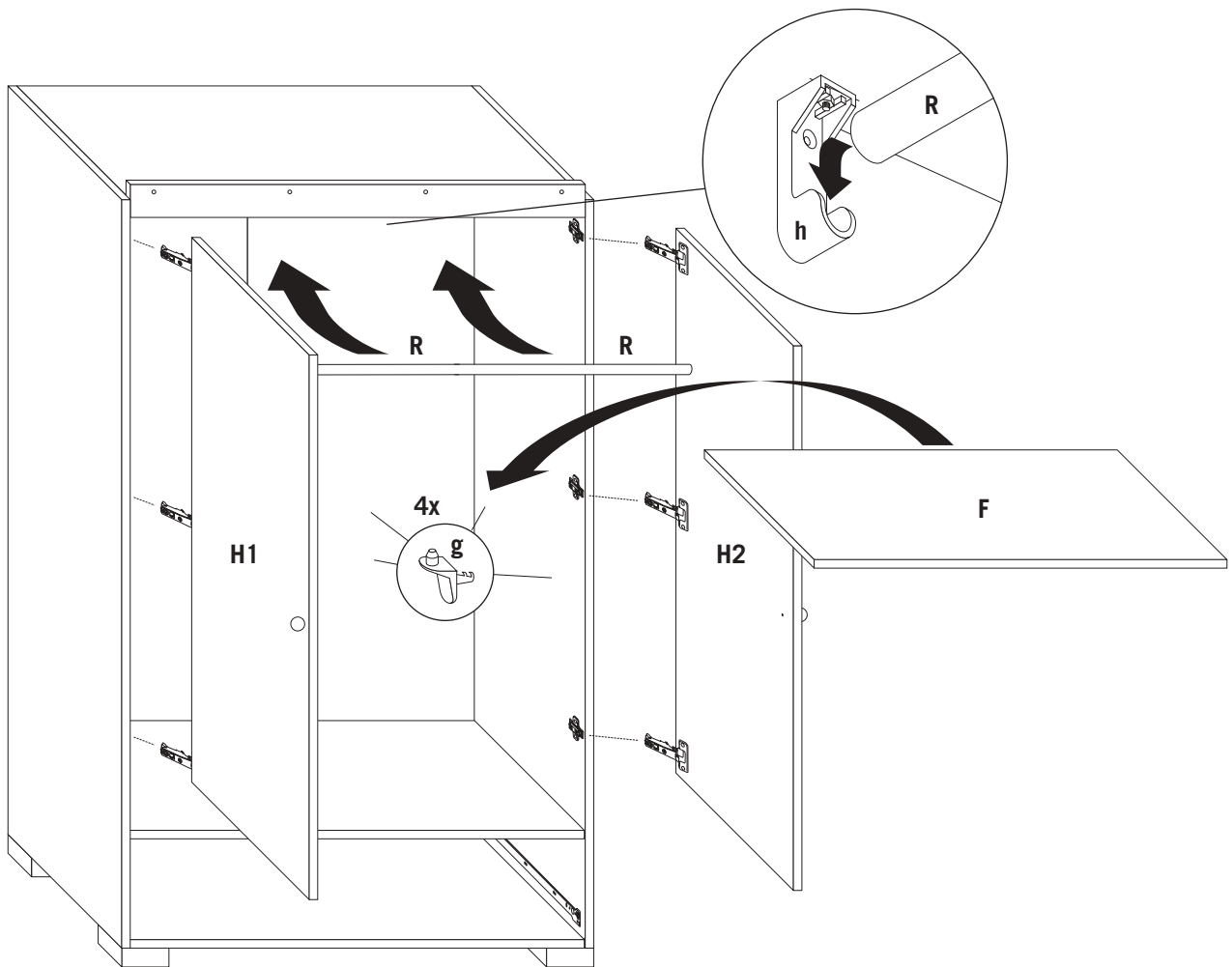

Step
10

Montaggio cassetto
Drawer assembly

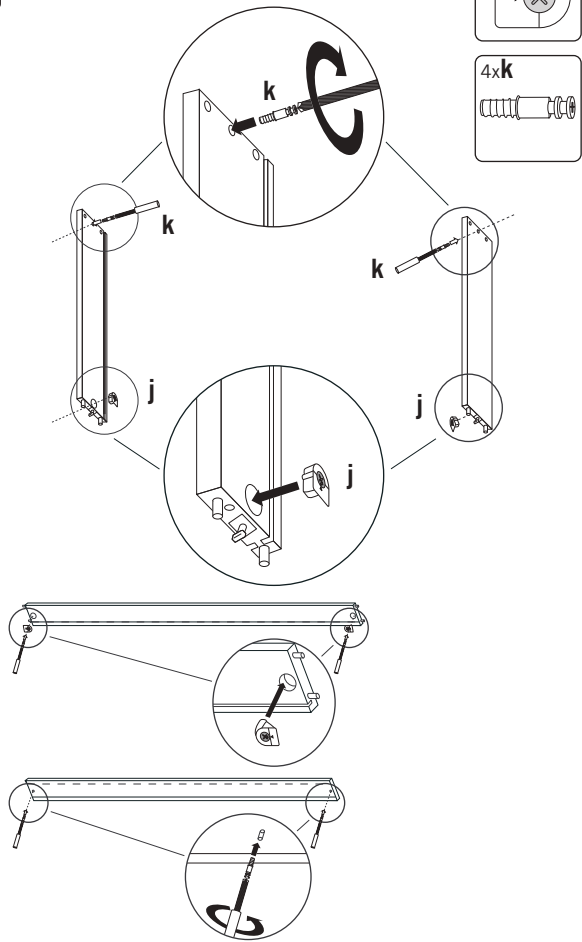

Step
11

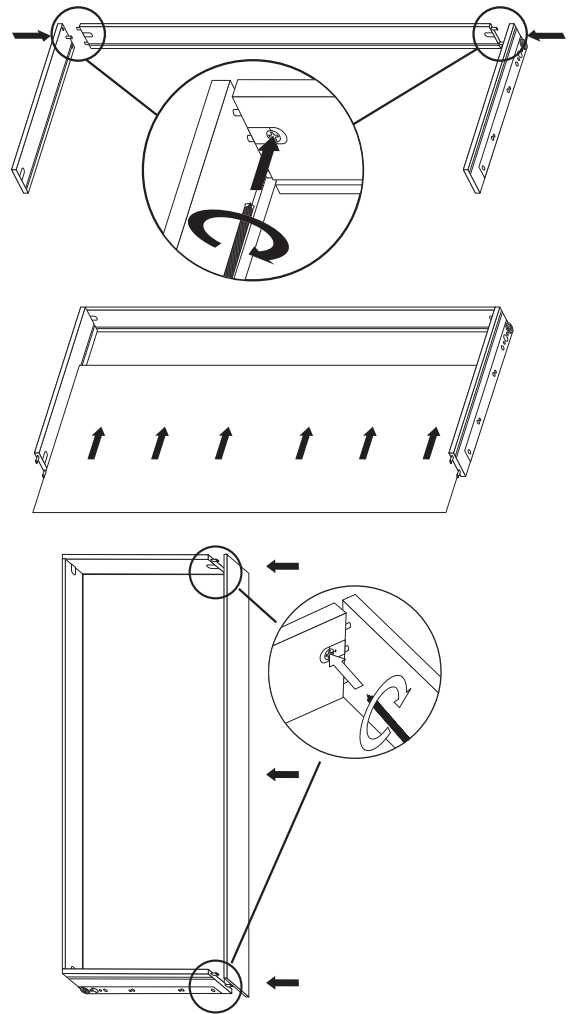

Step
12

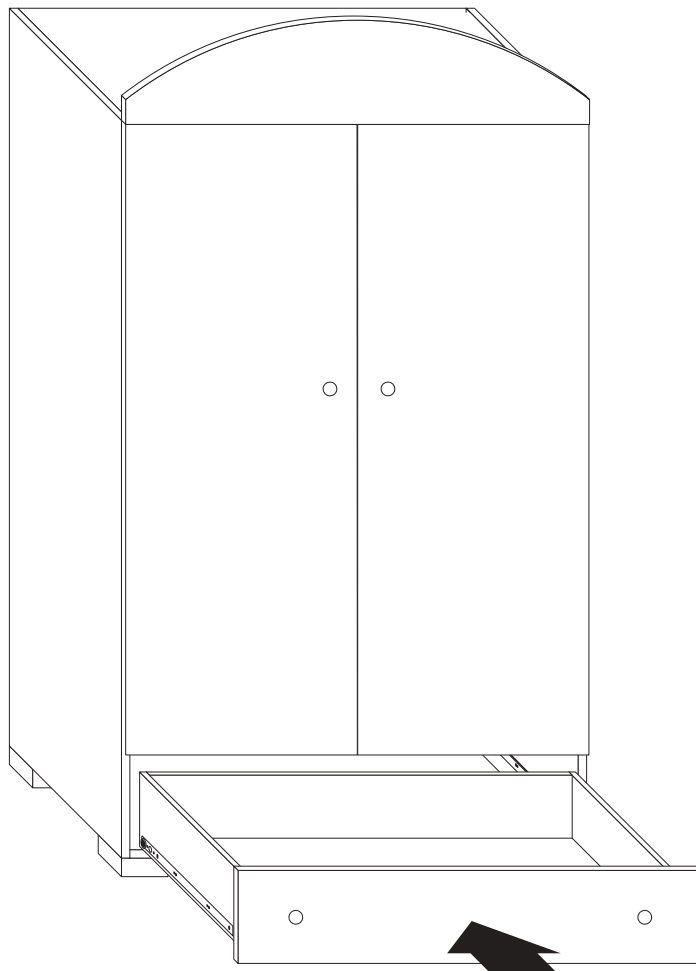

Scheda prodotto - Parts list description

Elemento <i>Part</i>	Quantità <i>Quantity</i>	Descrizione <i>Description</i>	Materiale componenti <i>Parts composition</i>
A1+A2	1+1	Fianchi sinistro + destro <i>Left + right side panels</i>	Pannello truciolare melamminico <i>Melamminic particleboard</i>
B1+B2	1+1	Schiene sinistra + destra <i>Left + right back panels</i>	Pannello truciolare melamminico <i>Melamminic particleboard</i>
C	1	Coperchio <i>Top panel</i>	Pannello truciolare melamminico <i>Melamminic particleboard</i>
D	1	Piano centrale <i>Medium panel</i>	Pannello truciolare melamminico <i>Melamminic particleboard</i>
E	1	Fondo <i>Bottom panel</i>	Pannello truciolare melamminico <i>Melamminic particleboard</i>
F	1	Ripiani <i>Shelves</i>	Pannello truciolare melamminico <i>Melamminic particleboard</i>
H	2	Ante <i>Doors</i>	MDF rivestito / Pannello truciolare melamminico <i>Coated MDF / Melamminic particleboard</i>
J	1	Cimasa <i>Top frontal</i>	Pannello truciolare melamminico <i>Melamminic particleboard</i>
L	1	Pannello frontale cassetto <i>Drawer front panel</i>	MDF rivestito / Pannello truciolare melamminico <i>Coated MDF / Melamminic particleboard</i>
M	1	Pannello posteriore cassetto <i>Drawer back panel</i>	Pannello truciolare rivestito <i>Coated particleboard</i>
N1+N2	1+1	Pannelli sinistro + destro cassetto <i>Drawer left + right panel</i>	Pannello truciolare rivestito <i>Coated particleboard</i>
O	1	Fascia frontale <i>Front rail</i>	Pannello truciolare melamminico <i>Melamminic particleboard</i>
P	1	Fondo cassetto <i>Drawer bottom panel</i>	MDF <i>MDF</i>
Q	4	Piedini <i>Feet</i>	Plastica ABS / Faggio massello <i>ABS plastic / Solid beechwood</i>
R	1	Tubi appendiabiti <i>Clothes hanging rails</i>	Metallo <i>Metal</i>
a	6	Cerniere ante <i>Doors hinges</i>	Metallo <i>Metal</i>
b	6	Basette per cerniere <i>Hinges supports</i>	Metallo <i>Metal</i>
c	24	Viti per cerniere e basette <i>Screws for hinges and supports</i>	Metallo <i>Metal</i>
d	12	Eccentrici <i>Eccentrics</i>	Metallo <i>Metal</i>
e	12	Tiranti <i>Stay bolts</i>	Metallo <i>Metal</i>
f	12	Tappi copriforo per eccentrici <i>Caps for eccentrics</i>	Plastica <i>Plastic</i>
g	4	Reggipiano <i>Shelf supports</i>	Metallo <i>Metal</i>
h	2	Reggitubo <i>Hanging rail supports</i>	Plastica <i>Plastic</i>
i	4	Viti per reggitubo <i>Screws for hanging rail supports</i>	Metallo <i>Metal</i>
J	4	Eccentrico per cassetto <i>Eccentrics for drawer</i>	Plastico / Metallo <i>Plastic / Metal</i>
k	4	Tirante per cassetto <i>Stay bolts for drawer</i>	Metallo <i>Metal</i>
m	4	Feltrini adesivi <i>Adhesive pads</i>	Stoffa <i>Fabric</i>
n	1	Bustina di colla <i>Glue bag</i>	Colla vinilica <i>Vinyl glue</i>
p	1	Chiave a brugola <i>Allen wrench</i>	Metallo <i>Metal</i>
q	4	Pomoli <i>Handles</i>	Plastica ABS / Faggio massello <i>ABS plastic / Solid beechwood</i>
r	4	Viti per pomoli <i>Screws for handles</i>	Metallo <i>Metal</i>
t	8	Viti per piedini <i>Screws for feet</i>	Metallo <i>Metal</i>
v	4	Spine in legno per cimasa <i>Wood pins for top frontal</i>	Faggio massello <i>Solid beechwood</i>
w	2	Viti per fissaggio cimasa <i>Screws for Top Frontal</i>	Faggio massello <i>Solid beechwood</i>